

# Product Specification

**Timestrip®PLUS 8 °C 48Hours**

**Button On Back**

**TP-175**

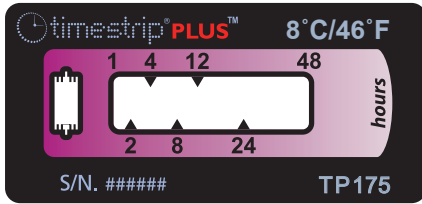

### General:

Each Timestrip®PLUS indicator is a small, self-adhesive label that can be attached to a product, package or carrying card\*. It monitors temperature and indicates when a maximum threshold has been breached. It is irreversible and also records the total time duration of one or more breaches.

\* see adhesive specification in Appendix 1 below for further details.

Each product in the range has been engineered for a different maximum threshold temperature so customers can choose the Timestrip®PLUS that best suits their needs.

### How to use:

Timestrip®PLUS indicators are completely inert prior to activation and can be stored at room temperature.

To activate Timestrip®PLUS, the surrounding temperature must be above the stated threshold temperature so that the blue dyed liquid can be released from the button. Fully squeeze the button and check that the first window turns blue and the word 'On' appears. If not, immediately re-squeeze the button fully. Within 2-3 minutes of activation, place the indicator below its STOP temperature for a minimum of 1 Hour so that the liquid freezes and the indicator is fully conditioned and ready to use. If the carrying card or the product to be monitored is already at or below the STOP temperature then the indicator can be stuck directly to it by removing the adhesive liner on the back.

Threshold Temp	Stop temp*	Run-Out window**	Time Marks in Hours
+8 °C/+46 °F	+6 °C/+43 °F	48 Hours	1, 2, 4, 8, 12, 24 & 48

\* The temp at which the run-time advancement (the movement of the blue dye) will stop.

\*\* The run-out window is calibrated to an isothermal temp of +2 °C above the stated/printed Threshold temp.

### I) Performance Specifications:

- Temp Accuracy: ± 1 °C/2 °F
- Time Accuracy: ± 15 % in time under isothermal conditions
- Progress Isotherms: See Fig. 1
- Display: Continuous, irreversible
- Usage: The usage of the product in any assembly or production line must be agreed upon in advance, as it may alter performance specifications.

### II) Product Specification:

- Button Position: Button on Back (BOB)
- Colour of Progressing Front: Blue
- Adhesive: #5464, Pressure sensitive, -40 °C - +100 °C, PE Double Sided Foam Tape – See Appendix 1
- Product drawing: See Fig. 2
- Graphics: See Fig. 3
- Other: Not suitable for immersion in water
- Remark: Run-time window length will vary slightly between production batches.



**the smart way to measure time & temperature**

---

### III) Product Construction:

The indicator is constructed of polymeric assembly multilayer and aluminium-plastic laminate. It encapsulates coloured liquid chemicals\*.

- \* Maximum weight of colorant is < 0.5 mg.
- \*\* Liquid chemicals are listed in the Food Chemicals Codex and/or approved by the Food and Drug Administration (FDA) under Title 21, and/or considered generally recognized as safe (GRAS).
- \*\*\* All materials are non-toxic, latex, silicon and PVC free.

### IV) Storage Conditions (un-activated):

- Store in a cool dark environment away from heat sources.
- Recommended: 22 °C/72 °F at 20-80% RH.
- Please note that before activation, the product can tolerate short term exposure. during transit (hours or a few days) to temperatures in the range -30°C to +55°C. However, long term storage should be under recommended conditions.

### V) Shelf-life:

- 2 Years – an expiry date is stated on each pack.

visit [www.timestrip.com](http://www.timestrip.com)

Fig 1: Progress Isotherm

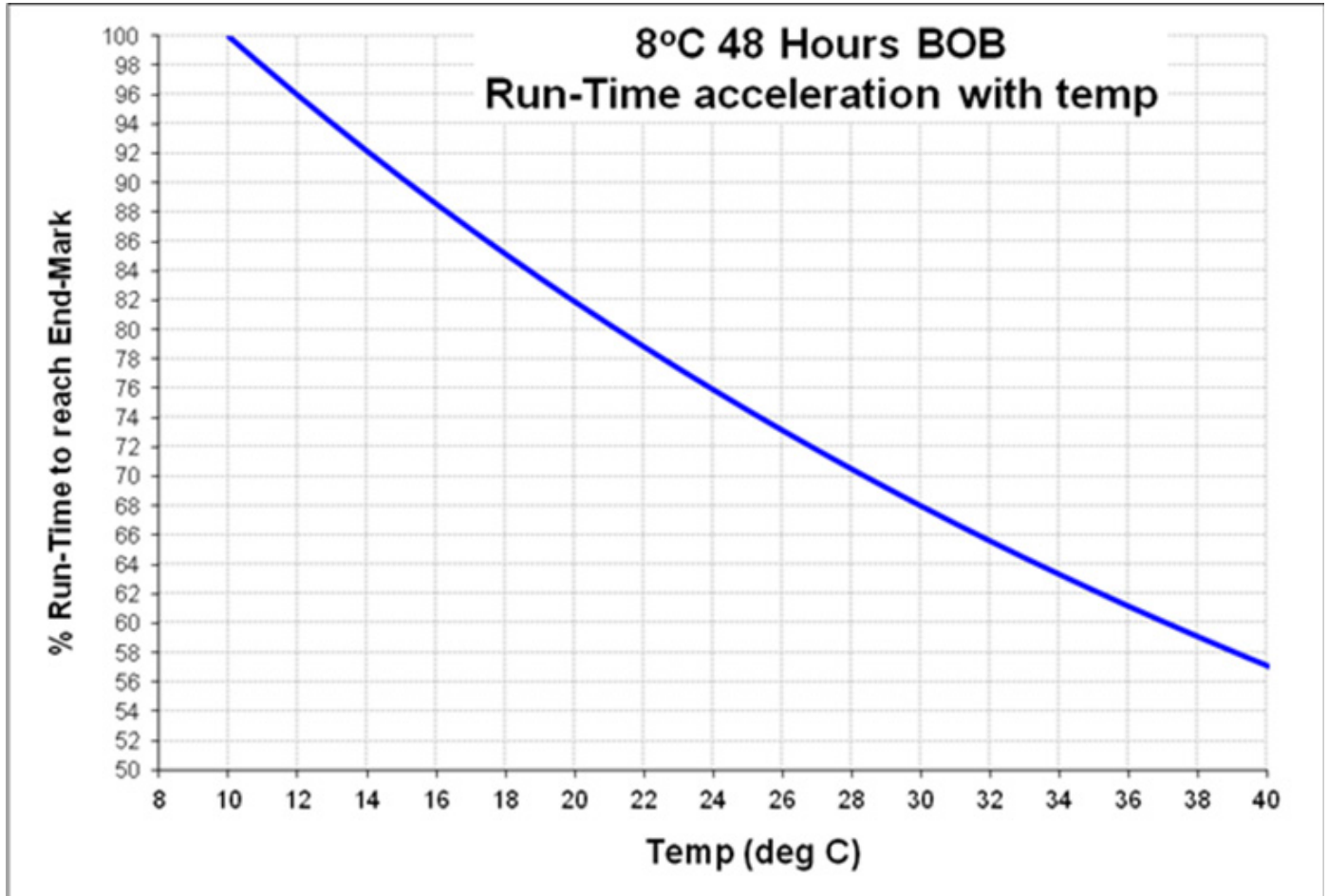

Fig 2: Product Drawing

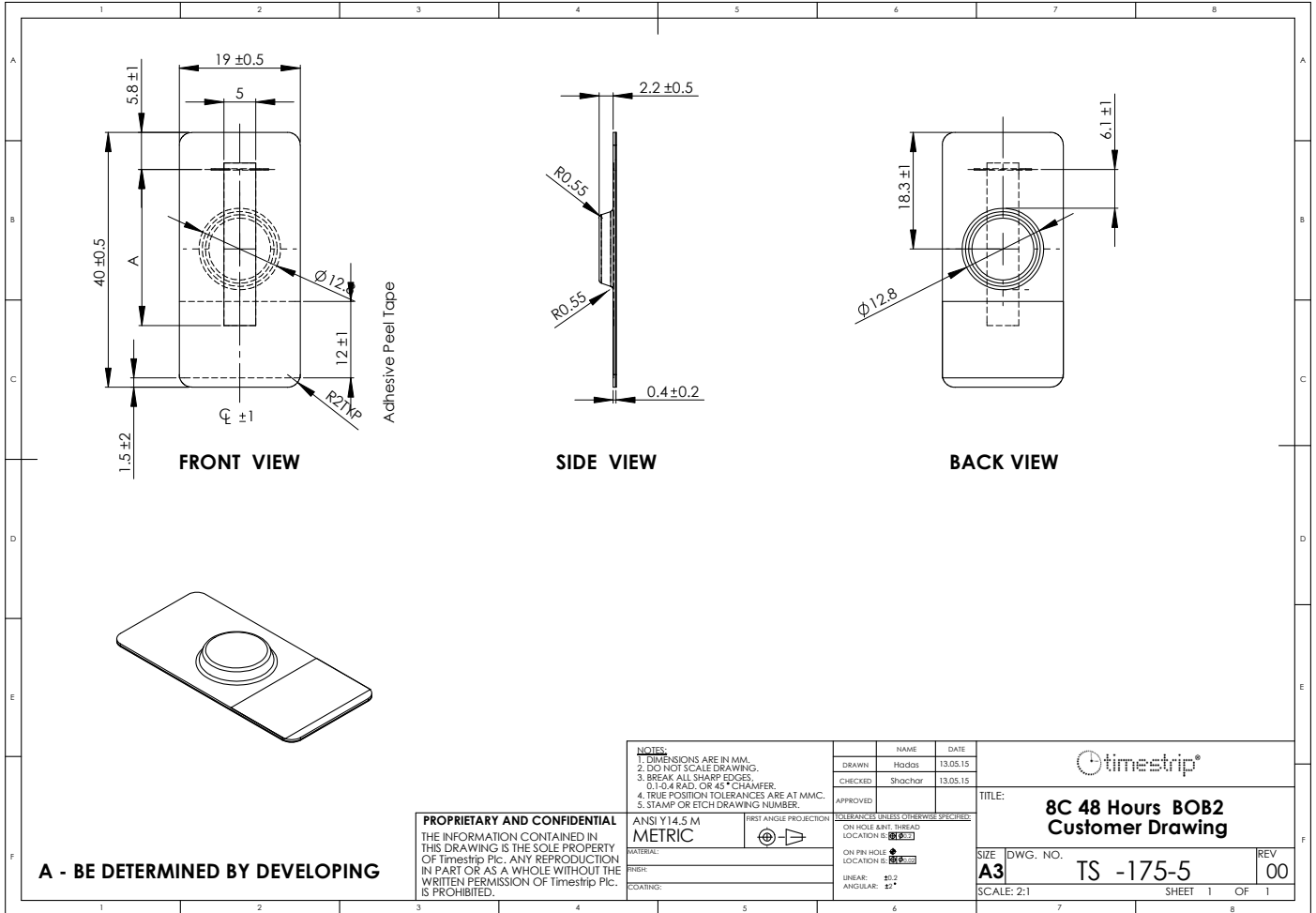
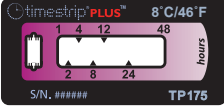
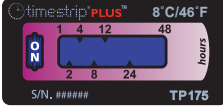
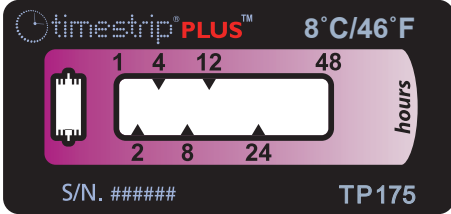

Fig 3: Graphics

100%

200%



P536 ec  
 1c 11m 10k  
 black  
 P485 ec  
 25c 96m 3y 10k

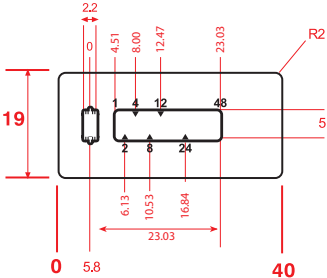

**\*For Approval:**

1. Print out, sign and Fax to + 972-9-899134 7  
or
2. Send a Mail with the approved graphics attached to mail.

<b>Customer approval *</b>			
<b>Name</b>		Title: 8C 48Hours BOB	
<b>Sign.</b>		Graphic 800-175	Rev. 0
<b>Date</b>			SH. 1 OF. 1
		Graphic Designer: Hadas 26.2.2015	
		LIn. -	
		Drawing No.:	
		Printing DWG:	



the smart way to measure time & temperature

## Appendix 1

### Scapa 5464

PE Double Sided Foam Tape

#### DESCRIPTION

Scapa 5464 is a general-purpose double-sided foam bonding tape. The product is white. The Polyethylene foam is predominantly closed celled. An acrylic pressure sensitive adhesive is coated on both sides, and the product has a paper release liner. The material can be supplied with a film liner facilitating automatic application.

#### APPLICATIONS

- For general mounting/bonding
- For automotive mirror mounting
- For mounting glazing bars
- For mounting cable trunking
- For preventing electrolytic corrosion
- Forms a compression water seal

#### PRODUCT BENEFITS

- Maximum Recommended Weight Loading of 22 g/cm<sup>2</sup>
- Service temperature -40 °C to +100 °C
- Application temperature: +10 °C to +40 °C
- Shelf life of 1 year
- Minimum 20% compression required to effect a water seal
- Coated on both sides with a high quality pressure sensitive acrylic adhesive
- Good resistance to dilute acids & alkalis
- Paper release liner, reducing dimensional change during application
- Very good Ultra violet (UV) Light resistant
- Resistance to abrasion, corrosion and moisture
- Suitable for indoor and outdoor environments
- No known hazards associated with this product
- May be used with Perspex & Polycarbonate
- Pre-determined dimensional sealant reduces waste
- Clean to use

#### ACCREDITATIONS

- Conforms to European Directive 2000/53 EC (lead, chromium VI, mercury, cadmium free)
- RES22LA06 type 1 (Rover)

#### TECHNICAL PROPERTIES

	Unit	Nominal Value	Test Method
10 Minute 180° Peel Adhesion	N/25mm	18	Scapa F9
500 Hour static shear (stainless steel)	Kg/cm <sup>2</sup>	0.32	Scapa F7
Dynamic Shear	N/cm <sup>2</sup>	41	Scapa F11

#### STANDARD PRESENTATION

- Formats: Logs, Rolls, Die Cuts, Spools
- Thickness: 1.0 & 2.0 mm
- Core: 76mm plastic core

#### RECOMMENDATIONS

Surfaces must be clean, dry, free from grease and dirt.  
Recommended cleaning agent is Propan-2-ol, (IPA). Please note manufacturer's safety instructions should be followed and customers are recommended to ensure compatibility of the solvent with their substrate.  
Ideal bonding substrates are those which are: clean, dry, flat, smooth, dust free & non-porous

Low temperatures may increase the risk of condensation, reducing the tack of the product.  
Life expectancy will vary with temperature and humidity.  
Product may be applied by hand direct from a roll applying even pressure.

Customers are recommended to make their own assessment of our products under their own conditions, for their own requirements.

QA-AD2 09/2013

#### Document information

Document Type	Identifying No.	Rev./Issue	Date
Graphics	800-175	00	26.02.15
Product Drawing	TS-175-5	00	13.05.15
Adhesive #5464 Data Sheet	QA-AD2	00	09/2013
Product Specification Sheet	--	01	08.10.15

visit [www.timestrip.com](http://www.timestrip.com)